

Data Sheet



Article number: 12621000080700

Description: Threaded pin 621 000 080.700
For M8

Measures

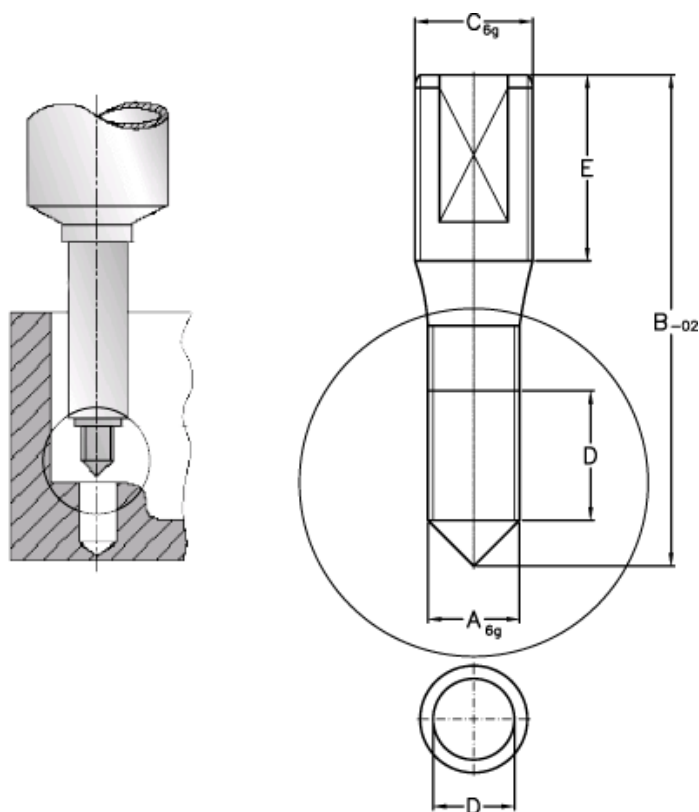

A = M8
B = 93.5
C = M8
D = 16.0
E = 20